

—

User manual and
installation instruction
Control Unit for Fire Ventilation

RV 24V-5A / RV 24V-24A / RV 24V-32A
RV 48V-5A / RV 48V-24A / RV 48V-32A

SMOKE VENT

- OK
- Battery low
- Line fault
- AC supply error
- Alarm active

Fire ventilation

Comfort ventilation

24VDC/48VDC max. 5A/24A/32A

2 actuator outputs

1 fire ventilation group, 2 comfort groups

Connection for fire switches, wind- and rain sensor, comfort switches, smoke detectors

Possibility for bus connection of 10 RV control units

Address of installation

Name: _____

Address: _____

Phone no.: _____

Contact person: _____

Date of installation: _____

Installation

Number of RV control units and type (ex. RV 24V-24A): _____

Number of fire ventilation groups: _____

Type of opening system: _____

Type of opening system: _____

Type of opening system: _____

External controls (AFA-CCS): _____

Comfort control: _____

Wind- and rain sensor: _____

220V power supply from group: _____

Table of contents

- Address of installation / Description of installation 2
- General description 4
- Safety rules during installation and operation 5
- Explosion danger..... 5
- Installation..... 5
- Yearly legal requirement of maintenance and control 5
- Connection to motor- (actuator) outputs and line monitoring 6
- Current limiter type LIP 7
- Operation and connection of fire switches 8
- Connection of smoke-/heat detectors 9
- Comfort ventilation - Connection and settings 9
- Diagramme RV control unit and connections 10-11**
- External LEDs on the front panel (LED board)..... 12
- Internal LED indication on the main board 12
- Fuse specifications 12
- Complete jumper settings 13
- Connection of more RV control units to one fire group (bus connection) 14
- Connection of weather sensor / Close all function 15
- External signal transfer, connection of AFA systems and other control systems..... 15
- Special functions 16
- Cable sizes 16-17
- Part nos. and accessories 18
- CE Declaration of conformity 19
- Technical specifications 20

Valid from board A042 V8.3 valid from software version XXX

Rev 0.03 19-01-2011

Manufacturer:

Actulux A/S
Haadvaerkervej 2
DK 9560 Hadsund
Danmark

Tel.: +45 98 57 40 90
Fax: +45 96 15 28 00
e-mail: info@actulux.com
www.actulux.com

General description

The RV control unit can be used for electrical opening of e.g. skylights, smoke hatches or similar in connection with fire- and comfort ventilation.

The RV control unit has different inputs with line monitoring which can be activated by e.g. fire switches, smoke detectors, heat detectors, AFA systems and CCS systems.

For control of the indoor climate (comfort ventilation) manual switches, weekly timer, room thermostat and outdoor weather sensors can be connected.

By means of LEDs in the the front panel the control indicates the operating condition (ok operation and error- and alarm condition), just as it by means of the built-in potential free relay contacts can re-lay operating information about ok operation and error- and alarm condition to other systems in the building.

The RV control unit is a part of a range of control units which are all built with a AC main supply and with either 24 or 48 volts DC motor supply. The range consists of the following types:

RV 24V-5A, RV 24V-24A, RV 24V-32A:

24 volts DC motor supply, power capacity 5A, 24A and 32A respectively.

RV 48V-5A, RV 48V-24A, RV 48V-32A:

48 volts DC motor supply, power capacity 5A, 24A and 32A respectively.

The polarity of the motor supply is reversed when opening or closing.

The RV control unit has built-in 72 hours battery back-up.

By a unique bus system consisting of a 3 wire cable the RV control units can be mutually connected so that up to 10 RV control units can be connected and operate as an integrated system.

Connection of cables to the in- and outputs of the RV control unit is described in the connection drawing on page 10-11.

A more detailed connection to the individual in- and outputs is described in the individual sections in this manual.

Selection of cable sizes on page 16.

By means of jumpers the RV control unit has different setting possibilities for in- and outputs. These settings are indicated in a complete table (please see section with jumper settings on page 12-13).

Examples of types of openings systems and the max. power consumption which can be connected to the RV control unit:

Type:	24V power supply:	48V power supply:
SA Power Single	4A	2A
SA Power Double	8A (2x4A)	4A (2x2A)
SA Power Large	8A	4A
Rotary 100	2,5A	1,25A
RA Light	2,5A	1,25A
Others	See specification of max. power consumption on the opening system	

Safety rules during installation and operation

The RV control unit may only be installed and maintained by personnel authorized for installation of automatic electrical fire ventilation equipment.

Explosion danger

The RV control unit is supplied with back-up batteries, which contain large amounts of energy which can be released as explosion in case of wrong handling - the following safety rules must therefore always be observed:

- ever short-circuit a back-up battery.
- Do not use external chargers on installed batteries. If unauthorized chargers are used explosive gasses can be released from the battery.
- Do not drop back-up batteries as strong acids can be released if they are broken.

Installation

The RV control unit can weigh up to 25 kgs and must be installed on a stable wall. Use either the pre-mounted flanges mounted on the backside of the cabinet or remove the flanges, and 6 mm screws can then be mounted through the steel bottom plate of the RV control unit, further through the plastic cabinet into the wall. The last mentioned way of installation may require that the batteries are dismantled in order to get access to the screw holes.

All cables are connected according to the drawing on the central pages and are dimensioned according to table page 16. Keep in mind that the operating voltage from the RV control unit is either 24V or 48V and that the max. voltage drop is 15% which demands correct cable dimension.

Please be aware that it often may be required (in order to keep the demands on the CE marking of the complete installation or another law) that the RV control unit is supplied with 230V AC from separate powerline with its own ground error circuit interrupter, and that a repair interrupter is mounted on the motor lines.

After connection the RV control unit must charge the batteries min. 12 hours before complete testing.

Yearly legal requirement of maintenance and control (authorized)

The functions of the RV control unit and the opening system must be tested by authorized personnel at least once a year. The RV control unit informs when the maintenance should be done. The external LEDs on the front panel flashes fast. The RV control unit and opening system are of course still full operating. Please call a service technician at your earliest convenience in order to carry out the maintenance and to test the control and opening system, in order to prepare it for another year of operation. The legal requirements for this must be observed and the testing and control must as a minimum include the following:

- Control that all opening systems move to full opening when the fire function is activated - should not be carried out if the wind is more than 6 m/sec. as there might be a risk that the opening system cannot close automatically.
- Control of the batteries. If the batteries are replaced it is important to use the same type as the batteries are carefully chosen to be able to deliver the current, for which the control is specified.
- Control of in- and outputs on the control.
- Control of fire switches and smoke- and heat detectors.

The batteries should be replaced as required, however at least every third year!

Connection to motor- (actuator-) outputs and line monitoring

The actuators (motors) must be connected to one of the 2 actuator outputs on the output terminals 2-3 or 4-5. It is possible to connect and disconnect the line monitoring on the 2 actuator outputs (the factory setting is “connected”). The cables to the actuators can be connected in series or parallel or a combination of these (please see drawing with examples or connection diagramme on the central pages). It is important to keep the right polarity of the cables - The actuators must always be connected through a current limiter, e.g. the Actulux LIP or similar.

Cable monitoring (line monitoring) on the motor outputs

The control is equipped with 3 possible settings for cable monitoring (line monitoring), which can be configured by means of jumper J7 (actuator output 1) and jumper J9 (actuator output 2).

Jumper J7 and J9 is mounted in pos. »Motor line«

Line monitoring between terminal 2-3 and 4-5. The jumpers J4 (actuator output 1) and J5 (actuator output 2) are set according to the number of termination resistors (27K) to be detected – for each actuator output 1 to max. 6 lines can be detected by moving the jumpers J4 and J5 respectively – this means that the cable installation between the RV control units and the actuators can be established in series connection (cable connection from e.g. skylight 1, further to skylight 2, etc.), or parallel connection (cable connection from each skylight to the control), or a combination of these. However, as mentioned max. 6 different lines can be detected each terminated with a 27K resistor.

For RV 24V-5A/RV 48V-5A the max. allowed current is 5A, e.g. 1 x 5A or 2 x 2.5A.

	Jumper description
J4	Number of connected 27Kohm termination resistors for actuator output 1
J5	Number of connected 27Kohm termination resistors for actuator output 2
J7	Chooses line monitoring through motor terminals 2-3 and 4-5 (Mot Mon) or separate wire terminals 1-3 and 5-6 (Ext Li Mon), or no line monitoring when J7/J4 or J9/J5 is removed.
F3	Fuse 15A (blue) for actuator output 1 24A+32A control units
F4	Fuse 15A (blue) for actuator output 2 24A+32A control units
F3	Fuse 5A (light brown) for actuator output 1 / 5A control unit
F4	Fuse 5A (light brown) for actuator output 2 / 5A control unit

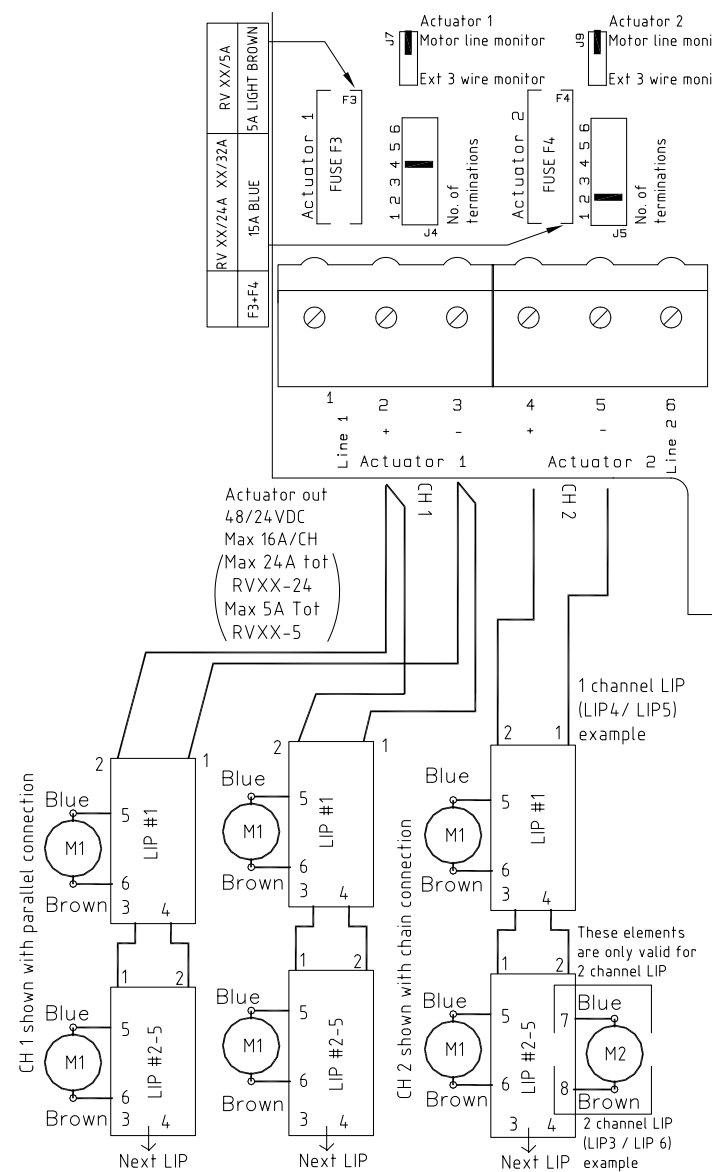

Jumper J7 and J9 mounted in pos. »Ext 3 wire«.

Line monitoring between terminal 1-3 and 5-6: With the jumpers J4 (actuator output 1) and J5 (actuator output 2) it is chosen, how many lines (number of 27K) you wish to detect - the same way as the motor line. This setting demands 3 wire cable from motor output to motor.

Jumper J7/J4 and J9/J5 are not mounted - No line monitoring for actuator output 1 and actuator output 2 respectively.

For RV 24V-5A/RV 48V-5A the max. allowed current is 5A, e.g. 1 x 5A or 2 x 2.5A.

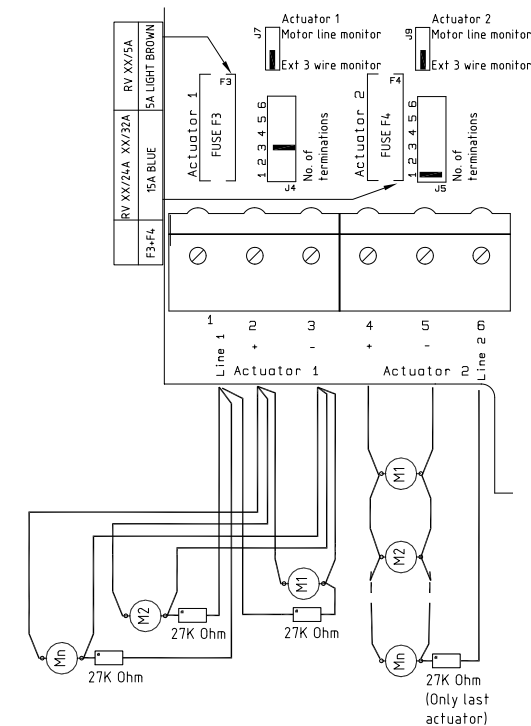

Current limiter type LIP function and setting (if mounted)

The current limiter type LIP (mounted on the opening system) is used as current limiter between the 48/24V DC supply and 1 or 2 actuators. When the adjusted current limit is reached, the speed of the actuators is reduced. When the max. power on the actuator is exceeded, the actuator stops. On the 24V/48V types (LIP5 or LIP6) max. 5 times overload cut outs in the same direction is allowed. After that it will not be possible to run in this direction again, before the motor has run in the opposite direction. This in order to protect the actuator gear mechanism.

Please note that when opening, the red LED in the LIP must light. This indicates that polarity to actuator is correct.

Table of LIP settings

Opening system	Not used	3A SA Power	4A SA Power	2,5 A Rotary 100
DIP 1	OFF	ON	OFF	ON
DIP 2	OFF	OFF	ON	ON

Type	Part no. board	Board description	Voltage and function	DIP 1	DIP 2	DIP 3	DIP 4	DIP 5	DIP 6	DIP 7	DIP 8
LIP3	111305	A028	24 V 2 channels	See diagram above	OFF	ON	27K ON	M1-M2 delay =ON	OFF	Test OFF	
LIP4	111315	A036	24 V 1 channel		27k ON	test OFF	Not mounted				
LIP3	111330	A040	24V 2 channels		OFF	ON	27K ON	M1-M2 delay =ON	OFF	Test OFF	
LIP5	121315	A043	24/48V 1 channel		27K ON	Not mounted					
LIP6 *	121330	A044	24/48V 2 channels		OFF	ON	27K ON	M1-M2 delay =ON	Not mounted		

* SA Power Large - parallel operation: Jumper OPT mounted - both motors stop at the same time if one stops because of overload.

Operation and connection of fire switches (e.g. type WSK 320)

The fire switch will generally contain the following:

- Breakable glass window and red control button is activated by pressure - this puts the RV control unit in ALARM condition, by which both motor outputs are activated (for normal service and testing the lid can be opened with a key).
- RESET button which brings the RV control unit out of the alarm condition and starts the closing sequence for about 60 seconds. Please note that RESET does not cancel errors on the system, e.g. line errors etc. These must be found and corrected.
- RED LED indicates that the RV control unit is in ALARM condition and that the motor outputs either are or have been activated.
- YELLOW LED indicates faults on the system - please call for a service technician.
- GREEN LED indicates that the system is in normal operation condition without errors.

CONNECTION of the fire switch is made as shown on the drawing.

The installation with fire switches must be terminated with a 10K or 27K resistor in the last switch in order to establish the line monitoring correctly – this can either be done by moving the factory mounted resistor from the terminal strip to the last fire switch or connect **jumper J1** in the fire switch type WSK 320 is mounted (by this a 10K resistor is also connected).

By means of jumpers the RV control unit has different possibilities of settings for the input to the fire switch:

Jumper J13 (Conf. firesw.):

Mounted = ALARM condition from 500-3K (indication of line error by direct short circuit or open circuit).

Dismounted = ALARM condition from 0-3K (indication of line error by open circuit).

Jumper J14 (FIRESW. 2 CH):

Mounted = 2 lines, which means that it is possible to connect 2 parallel lines, each with a number of serial connected fire switches.

Dismounted = 1 line, e.g. by connection of more fire switches, the cables are run from switch to switch in one line.

Jumper J15 (Failsafe):

Mounted = Any line error on fire switch or smoke detector puts the RV control unit in ALARM condition. This function can be used if cables to fire switches and smoke detectors are not fireproof).

Dismounted = An error condition does not report ALARM condition.

WSK 320

- 1 green LED OK (lights when OK and while closing)
- 2 yellow LED (lights on error)
- 3 red LED alarm (emergency opening)
- 4 ground (-)
- 5 not used
- 6 fire switch reset
- 7 fire switch emergency opening
- Jumper J1 must only be set in the last or only fire switch

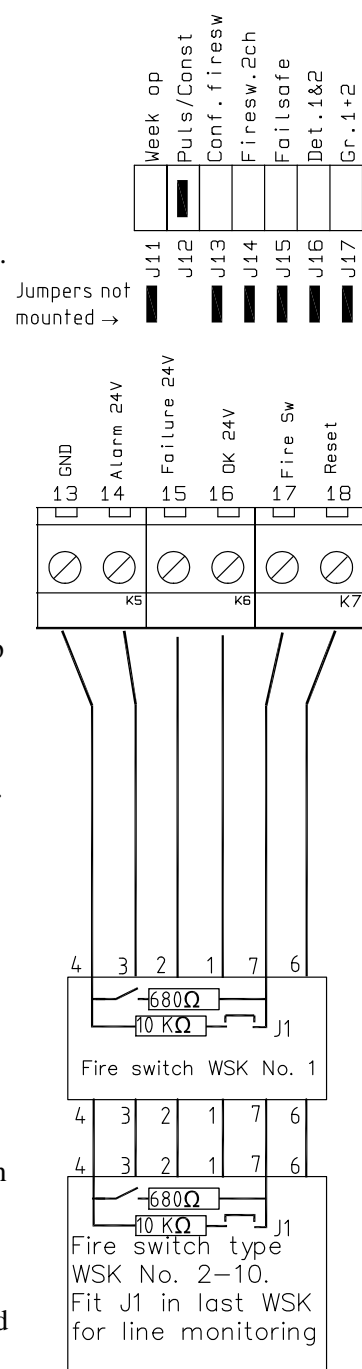
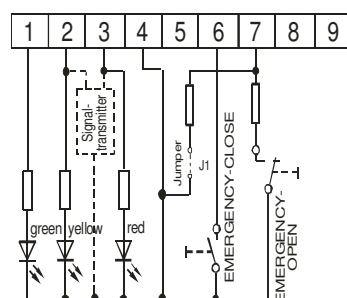

Connection of smoke-/heat detectors

Smoke- and heat detectors are connected as shown.

The installation can be carried out as 2 loops Dect.1 terminal 19 and 20 and Dect. 2 terminal 21 and 20 with max. 22 detectors on each circuit.

The last detector in each circuit must be terminated with a 10K termination resistor so that the cable monitoring (line monitoring) works correctly.

The following settings are possible:

Jumper J16 (Det. 1&2):

Mounted = Min. one detector should be activated in each of the 2 loops in the installation before the RV control unit goes into alarm condition (this function is used if the monitored room has potential possibility of limited local occurrences of smoke/heat in connection with daily use, e.g. because of passage of trucks in the building).

Not mounted = The RV control unit goes into alarm condition when only one detector is active, no matter in which of the 2 circuits in the installation the active detector is placed.

Line monitoring: Correct line monitoring can only be guaranteed with detectors delivered from the supplier. Other detectors may have different internal resistors and stand by power consumption.

Comfort ventilation – Connection and settings

Each of the 2 motor outputs can be controlled separately with their own comfort switch.

For comfort ventilation there are the following possibilities:

Jumper J17 (Gr. 1 +2):

Mounted = 1 comfort switch controls both outputs.

Jumper J12 (Puls/Const):

Mounted = It is possible to press the »up« button 3 times, which each gives 6 seconds of opening time at 24V (3 seconds at 48V) – after that nothing happens.

Continuous »up« signal gives 3x6(3) sec.=18(9) sec. - One press on »down« closes the actuator completely for a period which is 6 seconds longer than the complete opening time - In order to avoid »actuator pumping« max. 3 successive closing attempts will be allowed.

Not mounted = As long as »up« signal or »down« signal are given, the actuators are running.

Jumper J29 (Comf var.)

Mounted = The time on the above mentioned pulse opening can be adjusted from 2-20 sec. on the potentiometre RPT1.

Not mounted = The time on the above mentioned pulse opening is fixed (6 sec. at 24V / 3 sec. at 48V).

Room thermostats, weekly timers, CCS and other external control equipment for comfort ventilation can be connected on the inputs of the comfort control.

Indication about open or closed actuators:

111685 RV-control position indicator is a relay unit with 2 pcs. DPDT-contacts 230VAC 3A which indicates if the actuators are open or closed. Can only be used when J12 puls/const is mounted. The function can give information to burglar alarms, heat controls etc., if the actuators are open or closed.

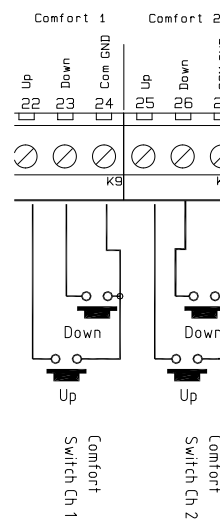
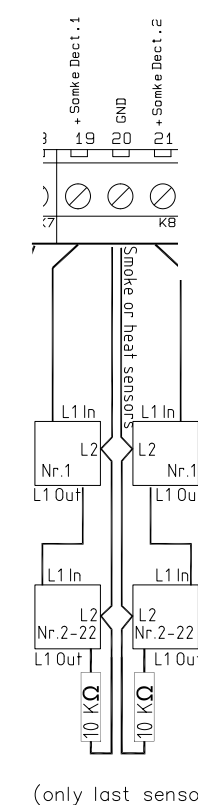
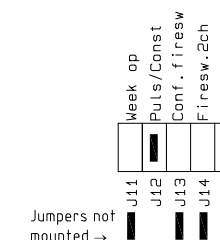

Connection RV 24V-32A/24A/5A

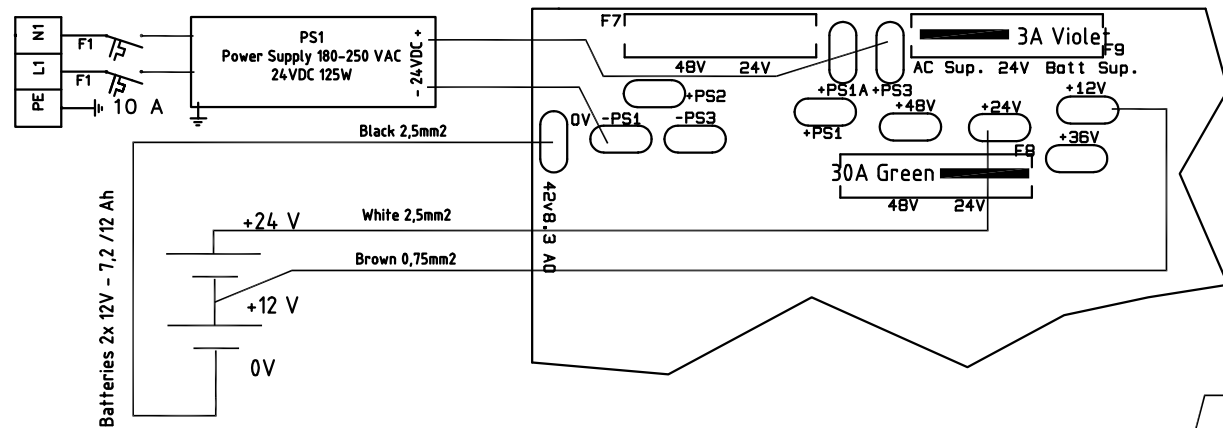
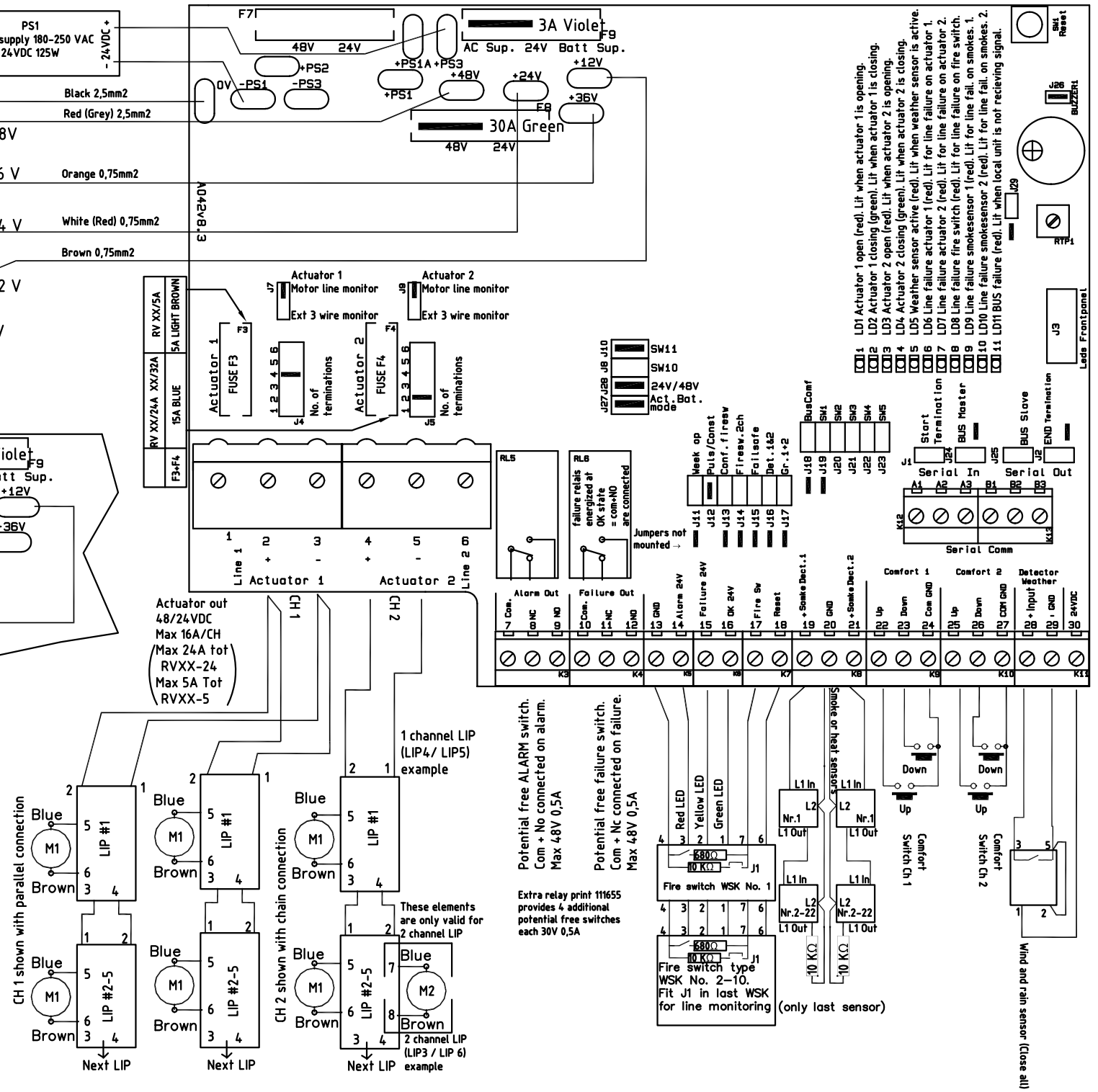

Diagram RV 48V-32A/24A/5A + RV 24V-32A/24A/5A Drawing 211701 rev_ -



External LEDs on the front panel (LED board)

		Operation possibilities for:	Alarm/ fire	Comfort operation
Text on front	Colour	Meaning: Switched off - lights - flashes		
OK	Green	lights if everything is ok switched off by local error on this control flashes by error message from other controls received by bus	LD12	Yes Yes
Battery low	Yellow	lights by local error on this control flashes by error message from other controls received by bus	LD13	Yes Only close
Line fault	Yellow	lights by local error on this control flashes by error message from other controls received by bus	LD14	Yes Only close
AC supply error	Yellow	lights by local error on this control flashes by error message from other controls received by bus	LD15	Yes Only close
Alarm active	Red	lights by local error on this control flashes by error message from other controls received by bus	LD16	Yes No
	All lights	time for yearly service - please call for supplier	LD12, 13, 14, 15, 16	Yes Yes

Internal LED indication on main board

	Operation possibilities for:	Alarm/fire	Comfort operation
LD1	Actuator 1 open (red). Lights when actuator 1 opens		
LD2	Actuator 1 close (green). Lights when actuator 1 closes		
LD3	Actuator 2 open (red). Lights when actuator 2 opens		
LD4	Actuator 2 close (green). Lights when actuator 2 closes		
LD5	Weather sensor active (red). Lights when weather sensor is active	Yes	No
LD6	Line error on actuator 1 (red). Lights when actuator 1 has line error	Yes	Only close
LD7	Line error on actuator 2 (red). Lights when actuator 2 has line error	Yes	Only close
LD8	Line error on fire switch (red). Lights when fire switch has line error	Yes	Only close
LD9	Line error on smoke detector 1 (red). Lights when smoke detector 1 has line error	Yes	Only close
LD10	Line error on smoke detector 2 (red). Lights when smoke detector 2 has line error	Yes	Only close
LD11	BUS error (red). Lights when BUS signal from other controls is missing. Only relevant if J24 or J25 is mounted.	Yes	Only close

Fuse specifications

Placement	24V	48V
Fuse value		
F7	Not mounted	Not mounted
F8 30A green	2 pcs. 12V batteries = 24V	4 pcs. 12V batteries = 48V
F9 3A violet	24VDC to terminal 30 - AC supply from 24V power supply - batt.supp. from the batteries - take care of discharging of the batteries when 230VAC is missing	24VDC to terminal 30 - AC supply from PSU - batt.supp. from the batteries - take care of the discharging of the batteries when 230VAC is missing

Complete jumper settings (standard setting marked in BOLD)

	Text on board	Factory mounted	Mounted function	Dismounted function
J1	Start termination	no	First control on the bus (hardware termination)	All other controls except the first on bus
J2	End termination	no	Last control on the bus (hardware termination)	All other controls except the last on bus
J3	Leds front panel		Connection for LED board in front plate	
J4	1 - 2 - 3 - 4 - 5 - 6	1	Connect according to number of 27K termination resistors on actuator 1	No line monitoring channel 1
J5	1 - 2 - 3 - 4 - 5 - 6	1	Connect according to number of 27K termination resistors on actuator 2	No line monitoring channel 2
J6	Programming		To be used for input of software (authorized personnel)	
J7	Mot Mon act. 1	yes	2 wire line monitoring via 27K terminal 2-3	No line monitoring channel 1
	Ext Li Mon act. 1	no	3 wire line monitoring with direct motor connection actuator 1	
J8	SW10	no	No function	
J9	Mot Mon act. 2	yes	2 wire line monitoring via 27K terminal 4-5	No line monitoring channel 2
	Ext Li Mon act. 2	no	3 wire line monitoring with direct motor connection actuator 2	
J10	SW11	yes		No function
J11	Week op	no	Open/close 3-4. sec. every week	No function
J12	PULS/CONS	yes	Actuator runs fixed time each time comfort switch is activated 6 sec. at 24V / 3 sec. at 48V	Actuator runs as long as comfort switch is activated
J13	Conf. firesw.	no	Fire switch with series resistors 0,5-3K. short circuit = line error	Fire switch without series resistors 0-3K. Short circuit = alarm
J14	Firesw. 2ch	no	2 parallel fire switch lines	1 fire switch line
J15	Failsafe	no	Line fault on fire switch and smoke detector put the control in alarm	Standard setting
J16	Detek 1&2	no	Alarm only on concurrent activation of one detector on each of the 2 lines	Standard setting: Alarm at armament of any detector.
J17	(Gr. 1+2)	no	One comfort switch controls both actuators. If J18 bus Comf. is mounted, Comfort Ch2 controls all RV control units on the bus	Actuator output 1 is controlled by Comfort Ch1 Actuator output 2 is controlled by Comfort Ch 2
J18	BusComf	no	Comfort Ch 2 controls and is controlled by all RV control units on the bus	Comfort Ch 1 and Comfort Ch 2 work independent of the bus
J19	SW1	no	Sprinkler function, close when smoke det. is active	Standard setting
J20	SW2	no	Not used	
J21	SW3	no	Not used	
J22	SW4	no	70-100°C heat detector can be mounted in each LIP	
J23	SW5	no	Not used	
J24		no	First control in the network	
J25		no	All other controls in the network	
J26	BUZZER1	yes	Acoustic alarm active	Acoustic alarm deactivated
J27	Actu. batt. mode	yes	Actuators are supplied by batteries	Actuators are supplied by 230/24V converter, batteries as backup
J28			48V controls (4 batteries)	24V controls (2 batteries)
J29	comf. var	no	Comfort pulse adjustable on RPT1 2-20 sec. (24V) / 1-10 sec. (48V)	Firm comfort pulse time 6 sec. (24V) / 3 sec. (48V)

Connection of more controls to one fire group (bus connection)

By means of a bus communication it is possible to make 2 – 10 RV control units to work as a complete system. The RV control units communicate with each other via a 3 wire bus connection. This could e.g. be a 3x0.5 mm² fireproof cable according to standard IEC 60-31.

Terminal no. A1, A2, A3 are for the incoming connection and B1, B2, B3 for the outgoing connection. In the first RV control unit start Bus J1 has to be on. This control is Master and J24 must therefore also be on. The bus cable is connected on the output terminals B1, B2, B3 and lead to the next RV control unit which is a slave, J25 must therefore be on. The cable is connected to the input terminals A1, A2, A3 of the next RV control unit and further to the next slave RV control unit from terminal B1, B2, B3. In the last slave RV control unit J2 and J25 must be on in order to terminate the bus connection.

- ALARM:** Connection of alarm inputs works across all controls so that if a fire switch or a smoke-/heat detector on one control is activated, all connected RV control units also goes into alarm condition.
- RESET:** If the reset button on one control or in one fire switch is activated, the reset function on all connected control is activated and starts the closing function on all motor output in approx. 60 sec.
- COMFORT:** The comfort control can work locally on each RV control unit or via the bus on more RV control units. If a wind- and rain sensor is connected it will work on all RV control units on the bus. Comfort switch Ch1 controls locally Actuator output 1. This function only applies without Jumper J17 mounted. Comfort switch Ch2 controls locally Actuator output 2. If J18 is mounted, the comfort switch 2 will control all other RV control units on the bus, where J18 is mounted.

Function description for RV control units connected with bus connection

If more RV control units are connected by means of a bus connection, the following are monitored/communicated between the RV control units:

- A detected bus error makes the LED LD11 on the main board light/flash.
- A detected bus error brings all controls on the bus connection in error condition (line error).
- If one of the RV control units in the network goes into alarm condition, all go into alarm condition.
- If one of the RV control units goes into a certain error condition (line error, AC error, battery error or bus error), the other RV control units also go into error condition – the type of the error is indicated on the board of the front plate of all RV control units – on the RV control unit(s) which have not caused the error, the ok LED on the board of the front plate flashes at the same time as the error. On the RV control unit(s) which have caused the error, the OK LED is switched off.

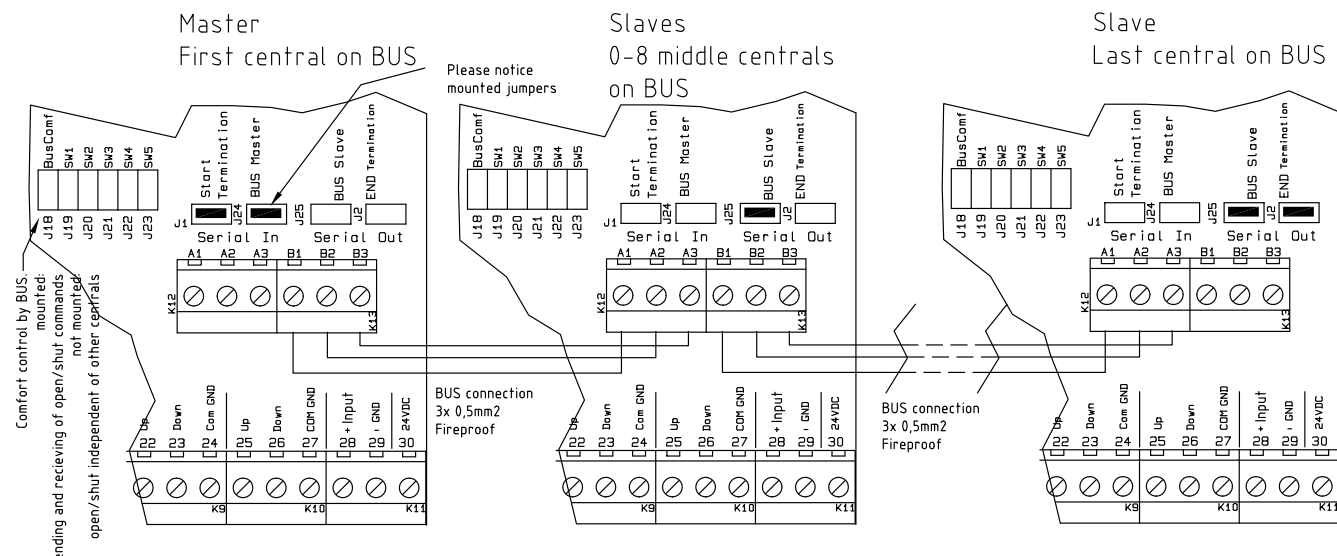

Connection of weather sensor / Close all function

A weather sensor can be connected to the RV control unit. The weather sensor is adjusted according to the instructions. Actuators should be closed when the wind is above 6 m/s. LED LD5 on the main board indicate active weather sensor ,lights as long as input is active.

As long as the weather sensor is active, motor inputs cannot be opened with comfort switches.

The weather sensor closes on all controls which are connected through bus connection.

On the input to weather station a weekly timer can be connected which makes sure that everything is closed, e.g. by end of a working day.

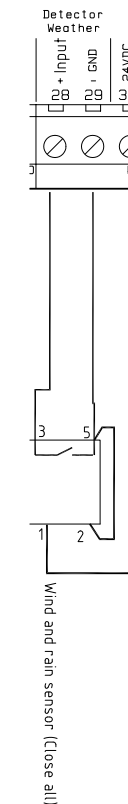

External signal transfer, connection to AFA systems and other control systems

The RV control unit can receive potential free alarm signals from e.g. AFA systems on the input to fire switch or smoke-/heat detector – Line monitoring resistor must be fitted on the contact in the AFA system.

The RV control unit can forward Alarm condition to external connected systems by means of potential free contacts on the terminals 7 (com), 8(NC) and 9(NO).

The RV control unit can forward Failure condition to external connected systems by means of potential free contacts on the terminals 10 (com), 11(NC) and 12(NO).

Alarm and error contacts work parallel on all controls connected with bus connection.

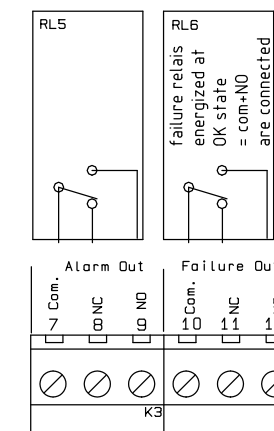

Potential free ALARM switch.
Com + No connected on alarm.
Max 48V 0,5A

Potential free failure switch.
Com + Nc connected on failure.
Max 48V 0,5A

Extra relay print 111655 provides 4 additional potential free switches each 30V 0,5A

Special functions

Sprinkler function:

Jumper J19 mounted - a special function comes in use where sprinkler systems are installed. With this function activated, both actuator outputs close, if smoke-/heat detector input is activated.
If the fire switch is activated, both actuator outputs open.

Weekly open/close:

Jumper J11 is mounted - both motor outputs open shortly (3 seconds) once a week and close immediately after - This function is used to give the right tension on the packing of the skylights to keep them watertight.

CO2 valve pulsating function:

Jumper J20 is mounted - on motor output 1 (CH1, terminal 2-3) e.g. an CO2 valve can be connected and the voltage on the output will pulsate and can operate magnetic coil (solenoid) in the valve which explodes and activates CO2 bottle - the connection polarity is important for the function of the line monitoring.

Function of heat detector in LIP:

Jumper J22 is mounted - a heat detector 70-100° can be mounted in each LIP. If the temperatur is exceeded, the RV control unit goes into alarm and the opening system is opening.

Cable sizes

It is very important to use the correct cable types and sizes to make sure that the fire ventilation system meets the standards and works correct in an emergency.
The two most important factors are the ability of the cables to resist heat and to make sure that the voltage drop in the cables to the actuators do not exceed 15% at full load on the fire ventilation hatches.

Fire resistant cables according to IEC 60331 must be used for the following functions:

Opening systems with actuators 24/48V	2 wires, see diagramme (3 wire by external line surveillance)
Fire switch 24V	Min. 6 x 0,5 mm ²
Smoke detector 24V	Min. 2 x 0,5 mm ²
Heat detector	Min. 2x0,5 mm ²
Cable between RV control units (bus)	3 x 0,5 mm ²

Normal cables can be used for the following functions:

Supply for control 230VAC	e.g. 3 x 1,5 mm ²
Comfort ventilation button 24V	Min. 3 x 0,5 mm ²
Wind- and rain sensor 24 V	Min. 4 x 0,5 mm ²

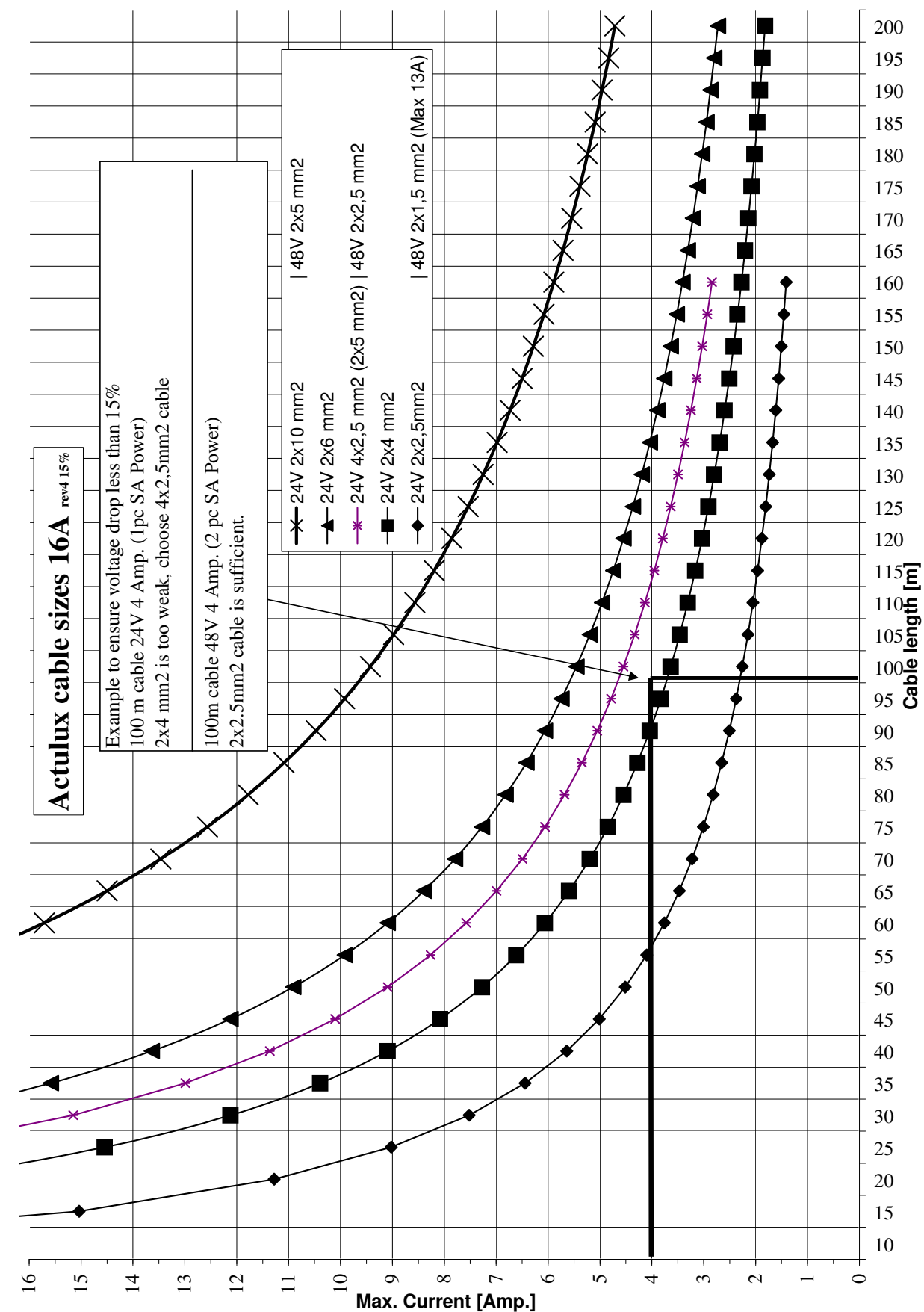

See motor power consumption page 4 or the type label on the system.

Parts nos. and accessories

	Name of part	Description
121606	RV48-48/32 Control PCB V	Main board
211050	Power supply 125W 24VDC MW	Power supply 230VAC/24VDC
211210	Circuit breaker 10A	Automatic fuse 10A / input terminal
800248	Battery 12V/7,2AH 151x65x98mm	Battery for 24 / 5A controls
111622	Battery 12V 12AH 151x94x98	Battery for 32 A controls
111617	Fuse 15A spade (blue auto)	Blue 15A fuse for actuator outputs (F3, F4) RV xxV-32A/24A
911812	Fuse 5A light brown	Light blue 5A fuse for RV xxV-5A (F3,F4)
111924	Green auto fuse,30a	Green 30 A fuse (F8)
911813	Fuse 3A spade Violet aut	3A fuse violet F9 24V supply external system
111710	Fire switch/reset IP40 Actulu	Fire switch IP 40
111703	Replacement glass f WSK	Replacement glass for fire switch
111702	Tool/key fireswitch WCP111720	Key for fire switch for operation without breaking glass
111725	Fireswitch WSK in IP65 BOX	Fire switch built in IP65 box
111730	Wind and rain sensor 24VAC/DC	Wind- and rain sensor closes everything when raining or strong wind
111735	Heat detector+base 75 degrees	Heat detector 75 degrees temperature activation
111741	Heat detector+base 90 degrees	Heat detector 90 degrees temperature activation
111740	Smoke detector, optical	Optical smoke detector
111742	Smoke detector, Ion detector	Ion smoke detector for invisible smoke
111753	Comfort switch OPUS w housing	Comfort switch Opus complete with housing
111758	Comfort switch FUGA w housing	Comfort switch Fuga complete with housing
111760	Weekly timer 1 channel	Weekly timer, can e.g. close everything in the evening
111761	Comfort sw.up/down OPUS IP44	Comfort switch Opus 44 white
111767	AUTO MAN switch OPUS w housin	Switch Auto. man. OPUS white, activates room thermostat or weekly timer
111770	Room thermostat RTR w.resis.	Room thermostat for control of comfort ventilation
111655	Relay PCB extra 2Xoutp.in box	Board with 2x2 extra relay outputs 30V 0,5A
111681	Relay box coil 24VDC Contacts 3x230V shift	Relay box with 3x230V shift contacts
111685	RV-control position indicator	Relay unit with 2 pcs. DPDT-contacts 230VAC 3A which indicates if the actuators are open or closed. Can only be used when J12 puls/const is mounted

Actulux

DECLARATION OF CONFORMITY (UK)
KONFORMITÄTSERKLÄRUNG (G)
OVERENSSTEMMELSESERKLÆRING (DK)
CERTIFICAT DE CONFORMITE (F)
ATTESTAZIONE DI CONFORMITÀ (IT)

We, **Actulux A/S**
Haandværkervej 2
9560 Hadsund
Denmark

declare under our sole responsibility that the product:
erklären in alleiniger Verantwortung, dass das Produkt:
erklærer under eget ansvar, at produktet:
certifions, sous notre propre responsabilité, que le produit :
dichiara sotto la propria responsabilità che il seguente prodotto:

RV 24-5, RV 24-24, RV 24-32, RV 48-5, RV 48-24, RV 48-32

(name, type or model, lot, batch or serial number, possible sources and numbers of items)
(Bezeichnung, Typ oder Modell, Los-, Chargen- oder Seriennummer, möglichst Herkunft und Stückzahl)
(navn, type eller model, mængde, parti eller serienummer, mulig oprindelse og stykantal)
(nom, type ou modèle, lot ou numéro de série, origine et quantité)
(nome, tipo o modello, lotto, serie o numero di serie, sorgenti possibili e numeri di articoli)

to which this declaration relates is in conformity with the following standard(s) or other normative document(s).
auf das sich diese Erklärung bezieht, mit der/den folgenden Norm(en) oder normativen Dokument(en).
übereinstimmt.

til hvilket denne erklæring henfører, er i overensstemmelse med de følgende standard(er) eller andre normgivende dokument(er).
référant à ce certificat est conforme au(x) standard(s) ou autre(s) document(s) normatif(s).
è conforme alle disposizioni e normative sotto indicati.

EN12101-10:2006
EN61000-6-2:2005 EN61000-6-4:2001
EN61000-3-2:2005 EN61000-3-3:1995

(Title and/or number and date of issue of the standard(s) or other normative document(s)
(Titel und/oder Nummer sowie Ausgabedatum der Norm(en) oder der anderen normativen Dokumente)
(Titel og/eller nummer samt udgivelsesdato for standard(er) eller andre normgivende dokument(er))
(Titre et/ou numéro ainsi que date de publication de(s) standard(s) ou autre(s) document(s) normatif(s)
(Titolo ed/o numero e data d'emissione dello standard o dell'altro documento/documenti normativo)

following the provisions of Directive 73/23/EEC - 89/336/EEC and 93/68/EEC.
gemäss den Bestimmungen der Richtlinie 73/23/EEC - 89/336/EEC und 93/68/EEC.
i henhold til direktivets bestemmelser 73/23/EEC - 89/336/EEC og 93/68/EEC.
selon les stipulations des directives 73/23/EEC - 89/336/EEC et 93/68/EEC.
ed alle direttive 73/23/EEC - 89/336/EEC ed 93/68/EEC.

Hadsund 3 March 2010
(Place and date of issue)
(Ort und Datum der Ausstellung)
(Sted og dato for udstedelse)
(Posto e data d'emissione)
(Lieu et date d'émission)

Jens Buus
(Name and signature or equivalent marking of authorized person)
(Name und Unterschrift oder gleichwertige Kennzeichnung des Befugten)
(Navn og underskrift eller ækvivalent mærkning af autoriseret person)
(Nome e firma o marcatura equivalente della persona autorizzata)
(Nom et signature ou apposition équivalente d'une personne autorisée)

Technical specifications RV 24V-5A/RV 24V-24A / RV 48V-5A/RV48V-24A:

Power supply	: 90-264V AC / 127 - 370V DC - max. 150VA
Operating temperature	: -5°C - +40°C
Density	: IP65
Colour	: RAL 7035
Dimensions WxHxD	: 300x300x210 mm
Weight incl. batteries	: 15 kgs
Battery capacity	: 24V (2x12V) 7,2 AH / 48V (4x12V) 7,2 AH
Max. total load	: 24 V DC 24A / 48V DC 24A 24V DC 5A / 48V DC 5A
Max. load each motor line	: 24V DC 16A / 48V DC 16A 24V DC 5A/ 48V DC 5A
Motor lines	: 2 pcs. (terminals 16mm ²)
Fire switch groups	: 1 group, max. 2x10 external fire switches
Comfort ventilation	: 2 groups, unlimited number of switches
Smoke- and heat detectors	: 2 lines max. 22 pcs. on each (totally 44 pcs.)
Wind- and rain sensor	: Input for close all
Serial connection of controls	: Bus connection integrates most functions
Alarm output	: Potential free SPDT change over max. 48V 0,5A
Fault output	: Potential free SPDT change over max. 48V 0,5A
Supply out	: 24VDC 0,5A ved 230VAC operation
Line surveillance	: Motor lines, fire switches, smoke detector inputs and bus connection

Technical specifications RV 24V-32A / RV 48V-32A:

Power supply	: 90-264V AC / 127 - 370V DC - max. 150VA
Operating temperature	: -5°C - +40°C
Density	: IP65
Colour	: RAL 7035
Dimensioner WxHxD	: 300x450x210 mm
Weight incl. batteries	: 25 kgs
Battery capacity	: 24V (2x12V) 12 AH / 48V (4x12V) 12 AH
Max. total load	: 24V DC 32A / 48V DC 32A
Max. load each motor line	: 24V DC 16A / 48V DC 16A
Motor lines	: 2 pcs. (terminals 16mm ²)
Fire switch groups	: 1 group, max. 2x10 external fire switches
Comfort ventilation	: 2 groups, unlimited number of switches
Smoke- and heat detectors	: 2 lines max. 22 pcs. on each (totally 44 pcs.)
Wind- and rain sensor	: Input for close all
Serial connection of controls	: Bus connection integrates most functions
Alarm output	: Potential free SPDT change over max. 48V 0,5A
Fault output	: Potential free SPDT change over max. 48V 0,5A
Supply out	: 24VDC 0,5A ved 230VAC operation
Line surveillance	: Motor lines, fire switches, smoke detector inputs and bus connection

Manufacturer:

Actulux A/S	Tel.: +45 98 57 40 90
Håndværkervej 2	Fax: +45 96 15 28 00
DK 9560 Hadsund	e-mail: info@actulux.com
Denmark	www.actulux.com